

# QDLASER

## QLF063A-AA /QLF063D-AA

660 nm 50mW FP LASER TO-CAN

C00111-02 July 2016



### 1. DESCRIPTION

The QLF063A-AA/QLF063D-AA are 660 nm quantum well laser devices designed for high output power application. The laser diode is mounted into a TO-56 header including a monitor PD and hermetic sealed with a flat glass cap.

### 2. FEATURES

- 660 nm FP-LD
- $\Phi$ 5.6mm TO-CAN package
- High output power and high slope efficiency
- Including monitor PD
- Two types of pin assignments: anode common type (QLF063A-AA)/cathode common type (QLF063D-AA)

### 3. APPLICATIONS

- Industrial laser markers
- Measuring instruments
- Life science applications

### 4. ABSOLUTE MAXIMUM RATING

(CW operation,  $T_c = 25^\circ\text{C}$ , unless otherwise specified)

PARAMETER	SYMBOL	RATING	UNIT
Optical output power	$P_o$	60	mW
LD reverse voltage	$V_{RLD}$	2	V
PD reverse voltage	$V_{RPD}$	30	V
Operation temperature	$T_c$	-10 to 60	$^\circ\text{C}$
Storage temperature	$T_{stg}$	-40 to 85	$^\circ\text{C}$

Distributed by  imm photonics

Ohmstrasse 4 85716 Unterschleissheim Germany  
Tel.: +49 89 / 3214120 Fax: +49 89 / 32141211

www.imm-photonics.de  
sales@imm-photonics.de

## 5. OPTICAL AND ELECTRICAL CHARACTERISTICS

( $T_c = 25^\circ\text{C}$ , unless otherwise specified)

PARAMETER	SYMBOL	TEST CONDITION	MIN	TYP	MAX	UNIT
Threshold current	$I_{th}$	CW	-	55	70	mA
Operation current	$I_{op}$	CW, $P_o=50\text{ mW}$	-	100	135	mA
Operation voltage	$V_{op}$	CW, $P_o=50\text{ mW}$	-	2.3	2.8	V
Slope efficiency	$\eta$	CW, $P_o=5 - 50\text{ mW}$	0.8	1.1	-	W/A
Monitor current	$I_m$	CW, $P_o=50\text{ mW}$ , $V_{RD}=5\text{ V}$	25	150	300	$\mu\text{A}$
Peak wavelength	$\lambda_p$	CW, $P_o=50\text{ mW}$	655	660	665	nm
Beam divergence horizontal	$\theta_h$	CW, $P_o=50\text{ mW}$ (FWHM)	7	10	13	deg.
Beam divergence vertical	$\theta_v$	CW, $P_o=50\text{ mW}$ (FWHM)	11	14	17	deg.
Beam angle Horizontal	$\Delta\theta_h$	CW, $P_o=50\text{ mW}$	-3	-	3	deg.
Beam angle vertical	$\Delta\theta_v$	CW, $P_o=50\text{ mW}$	-3	-	3	deg.

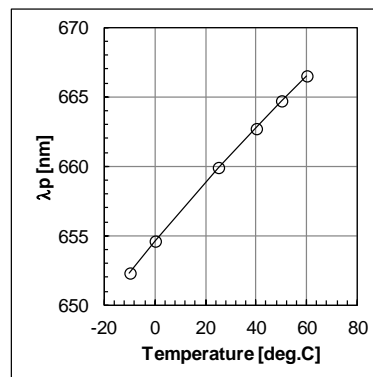
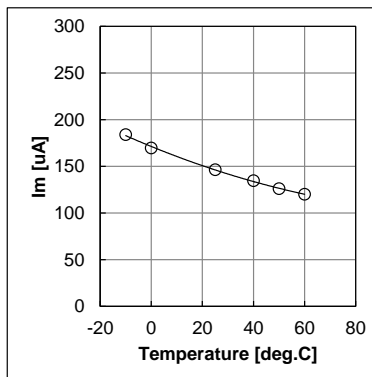
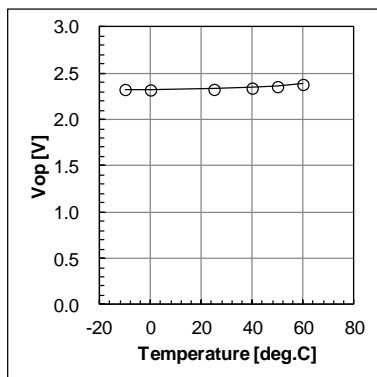
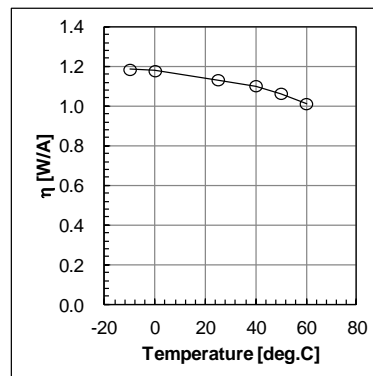
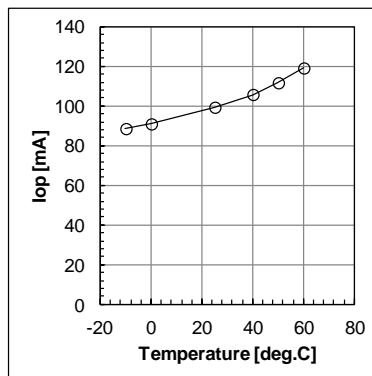
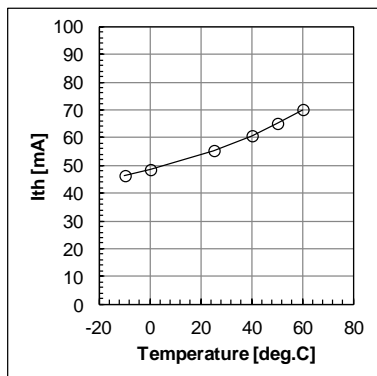

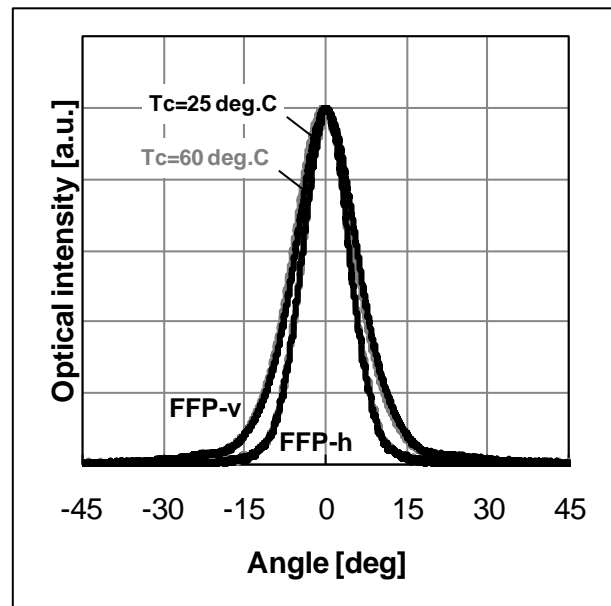
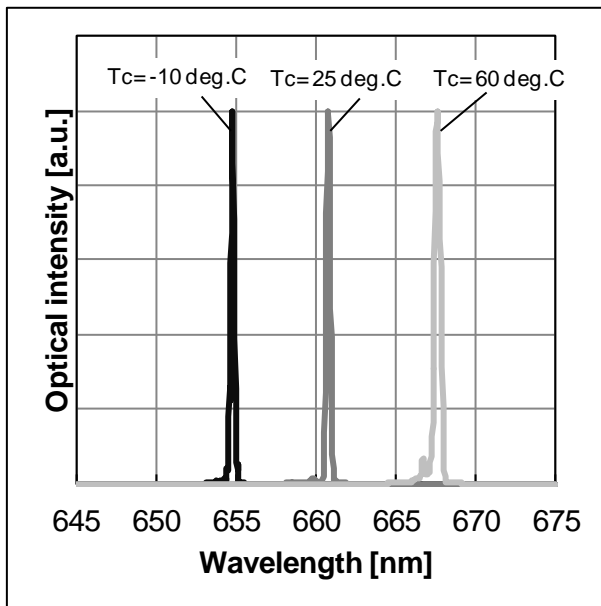
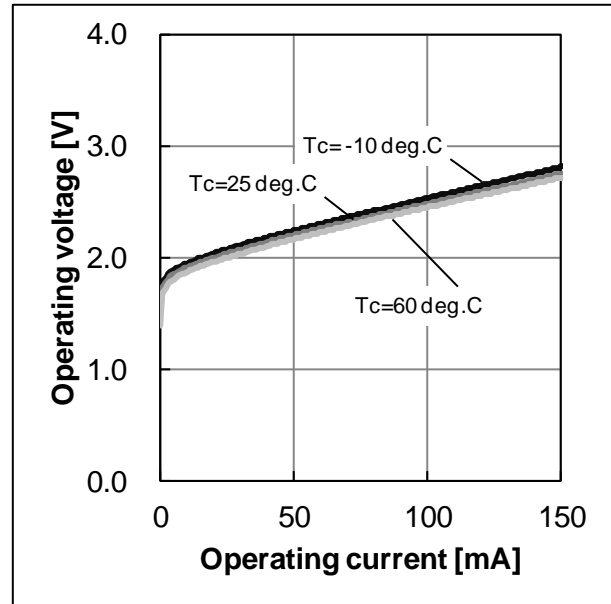
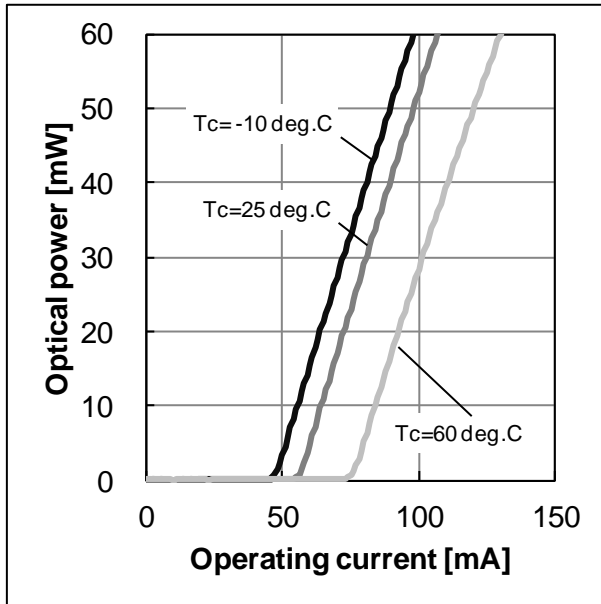

## 6. OUTLINE DRAWINGS

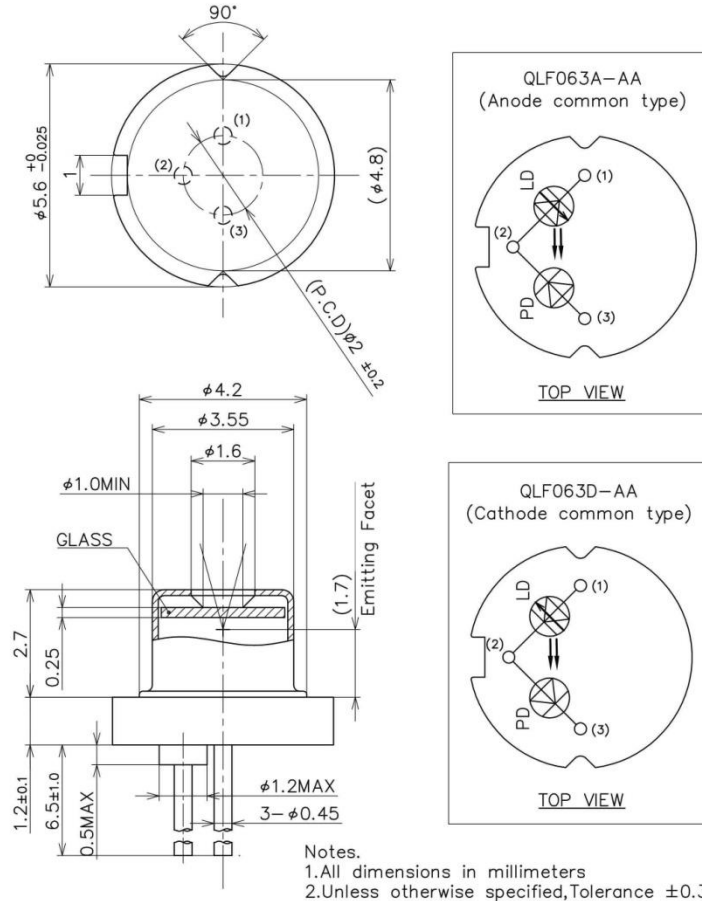

## 7. NOTICE

- Safety Information

This product is classified as Class 3B laser product, and complies with 21 CFR Part 1040.10.

Please do not take a look laser lighting in operations since laser devices may cause troubles to human eyes.

Please do not eat, burn, break and make chemical process of the products since they contain GaAs material.

- Handling products

Semiconductor lasers are easily damaged by external stress such as excess temperature and ESD.

Please pay attention to handling products, and use within range of maximum ratings.

QD Laser takes no responsibility for any failure or unusual operation resulting from improper handling, or unusual physical or electrical stress.

- RoHS

This product conforms to RoHS compliance related EU Directive 2011/65/EU.

QD Laser, Inc.

Contact : [info@qdlaser.com](mailto:info@qdlaser.com) <http://www.qdlaser.com>

Copyright 2013-2016 All Rights Reserved by QD Laser, Inc.

Keihin Bldg. 1F 1-1 Minamiwatarida-cho, Kawasaki-ku, Kawasaki, Kanagawa Zip 210-0855 Japan

All company or product names mentioned herein are trademarks or registered trademarks of their respective owners. Information provided in this data sheet is accurate at time of publication and is subject to change without advance notice.

Distributed by  imm photonics

Ohmstrasse 4 85716 Unterschleissheim Germany  
 Tel.: +49 89 / 3214120 Fax: +49 89 / 32141211

[www.imm-photonics.de](http://www.imm-photonics.de)  
[sales@imm-photonics.de](mailto:sales@imm-photonics.de)