

iC-TL46 BLCC SD1C

Blue LED - SMD, 3.4 mm spot size



Rev B1, Page 1/7

FEATURES

- ◆ Emission peak at 460 nm
- ◆ Optimized irradiance pattern
- ◆ Temperature range -40 to 125 °C
- ◆ High switching speed
- ◆ Packages suitable for SMT mounting

APPLICATIONS

- ◆ Illumination for high resolution optical encoder
- ◆ Modulated light barriers

PACKAGE

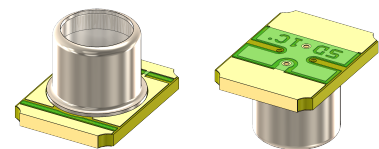

BLCC SD1C

DIMENSIONS

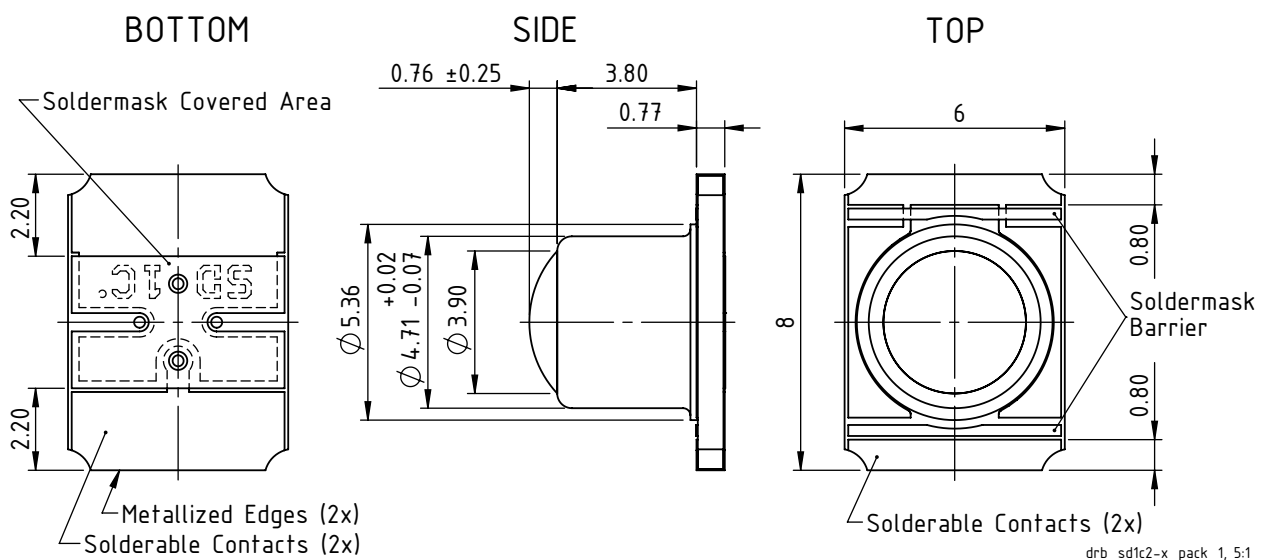

iC-TL46 BLCC SD1C

Blue LED - SMD, 3.4 mm spot size



Rev B1, Page 2/7

PACKAGING INFORMATION

PIN CONFIGURATION SD1C

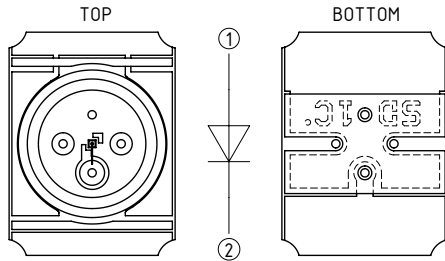

PIN FUNCTIONS

No. Name Function

1	A	Anode
2	C	Cathode

ABSOLUTE MAXIMUM RATINGS

Beyond these values damage may occur ($T_a = 25^\circ\text{C}$, unless otherwise noted)

Item No.	Symbol	Parameter	Conditions	Min.		Max.		Unit
G001	IF	Forward Current (DC)				50		mA
G002	IFSM	Surge Forward Current	1/10 duty cycle @ 1 kHz			100		mA
G003	VR	Reverse Voltage				5		V
G004	P	Power Dissipation	Case temperature 25°C			150		mW
G005	Tj	Junction Temperature		-40		125		°C

All voltages are referenced to ground unless otherwise stated.

All currents flowing into the device pins are positive; all currents flowing out of the device pins are negative.

iC-TL46 BLCC SD1C

Blue LED - SMD, 3.4 mm spot size



Rev B1, Page 3/7

THERMAL DATA

Item No.	Symbol	Parameter	Conditions				Unit
				Min.	Typ.	Max.	
T01	Ta	Operating Ambient Temperature Range		-40		125	°C
T02	Ts	Storage Temperature Range		-40		125	°C
T03	Tpk	Reflow Soldering Peak Temperature	Convection reflow: tpk < 20 s, MSL 1 (unlimited floor live at 30 °C and 60 % RH); Please refer to customer information file No. 7 for details. Not suitable for vapor phase soldering.			260	°C
T04	Rthja	Thermal Resistance Junction to Ambient			270		K/W

ELECTRICAL CHARACTERISTICS

Ta = 25 °C, unless otherwise noted

Item No.	Symbol	Parameter	Conditions				Unit
				Min.	Typ.	Max.	
Electrical and Optical Characteristics							
001	VF	Forward Voltage	IF = 20 mA		2.9	3.8	V
002	VR	Reverse Voltage	IR = 5 µA	5			V
003	ϕ_e	Radiant Power	IF = 20 mA	5	6.5		mW
004	TK(ϕ_e)	Temperature Coefficient of Radiant Power	IF = 20 mA, Tj = 25 °C...125 °C		-0.3		%/K
005	λ_p	Peak Wavelength	IF = 20 mA	450	460	470	nm
006	$\Delta\lambda$	Spectral Half Width	IF = 20 mA		25		nm
007	2 ϕ	Divergence, Far Field	IF = 20 mA, FWHM (Full Width Half Maximum)		3.5		deg.
008	tr, tf	Switching Time	Pulsed IF = 100 mA, RL = 50 Ω		20		ns

iC-TL46 BLCC SD1C

Blue LED - SMD, 3.4 mm spot size



Rev B1, Page 4/7

DIAGRAMS

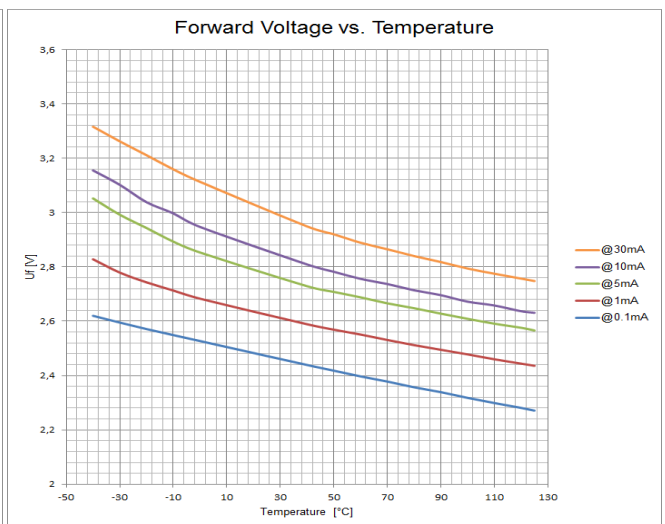
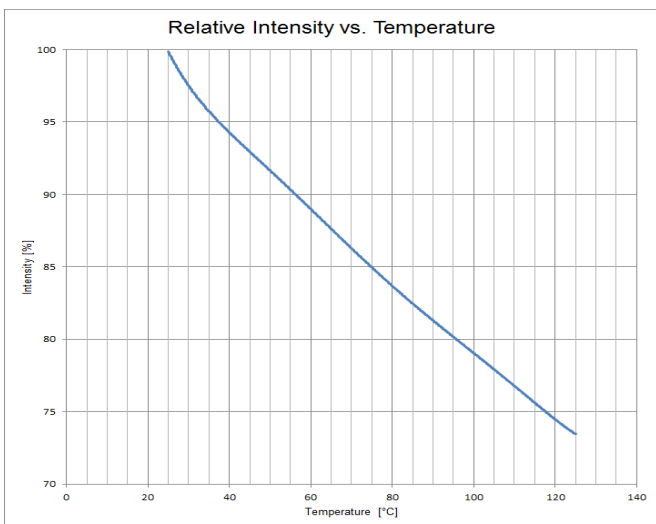
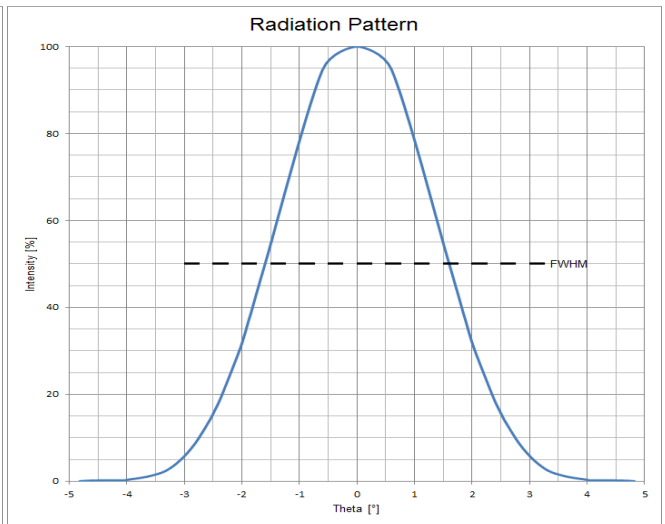
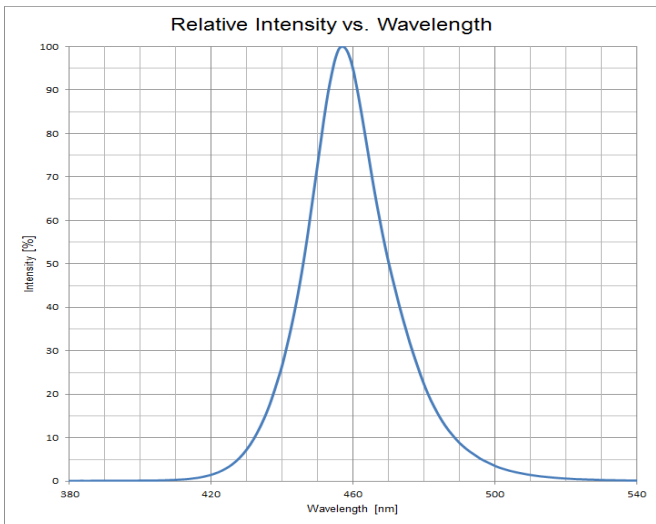
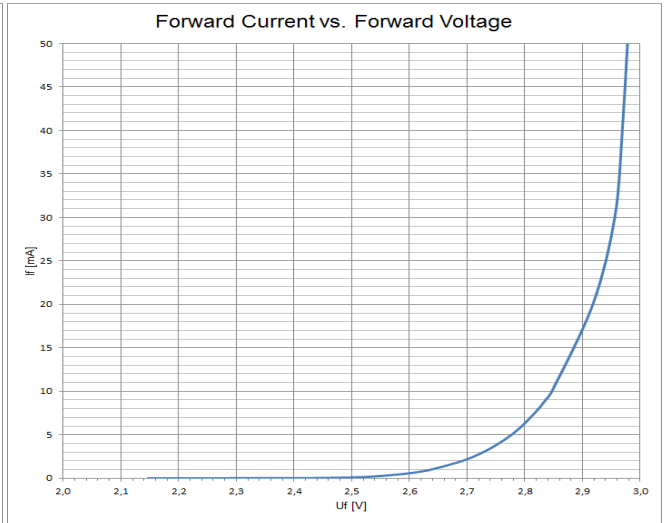
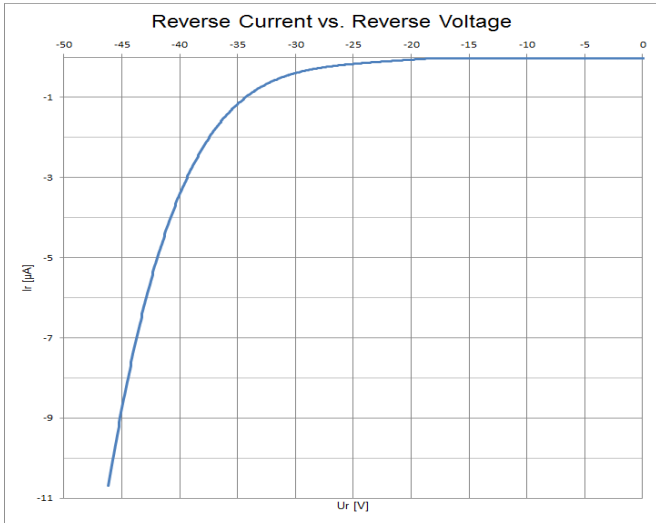

iC-TL46 BLCC SD1C

Blue LED - SMD, 3.4 mm spot size



Rev B1, Page 5/7

SAFETY ADVICES

Depending on the mode of operation, these devices emit highly concentrated visible blue light which can be hazardous to the human eye. A direct and prolonged irradiation of the eye especially with short wavelengths should be avoided. For assembly activities during op-

eration protective glasses and appropriate instructions are recommended. Products which incorporate these devices have to follow the safety precautions given in IEC 62471.

GENERAL NOTICE

Epoxy resins (such as solder resists, IC package and injection molding materials, as well as adhesives) may show discoloration, yellowing, and surface changes in general when exposed longterm to high temperatures, humidity, irradiation, or due to thermal treatments for soldering and other manufacturing processes.

Equally, standard molding materials used for IC packages can show visible changes induced by irradiation,

among others when exposed to light of shorter wavelengths, blue light for instance. Such surface effects caused by visible or IR LED light are rated to be of cosmetic nature, without influence to the chip's function, its specifications and reliability.

Note that any other material used in the system (e.g. varnish, glue, code disc) should also be verified for irradiation effects.

HANDLING ADVICES

Because of the specific housing materials and geometries used, these LED devices are sensitive to rough handling or assembly and can thus be easily damaged

or may fail in regard to their electro-optical operation. Excessive mechanical stress or load on the lens surface or to the glued cap must be avoided.

DESIGN REVIEW: Notes On Chip Characteristics

iC-TL46			
No.	Chip Design	Function, Parameter/Code	Description and Application Hints
1	iC-TL46	initial chip release	

Table 4: Notes on chip characteristics

iC-TL46 BLCC SD1C

Blue LED - SMD, 3.4 mm spot size



Rev B1, Page 6/7

REVISION HISTORY

Rel.	Rel. Date*	Chapter	Modification	Page
A1	2015-01-09	...	Initial release	all

Rel.	Rel. Date*	Chapter	Modification	Page
A2	2015-09-09	PACKAGING INFORMATION	Added LED symbol	all

Rel.	Rel. Date*	Chapter	Modification	Page
A3	2017-01-31	ABSOLUTE MAXIMUM RATINGS	Item G005: Junction Temperature	2
		THERMAL DATA	Item T01: Extended Temperature Range, item T02: Storage Temperature Range	3
		DESIGN REVIEW	Added Chip Design	5

Rel.	Rel. Date*	Chapter	Modification	Page
B1	2019-08-21	PACKAGE	BLCC package drawing	1
		DIMENSIONS	BLCC package drawing	1
		PACKAGING INFORMATION	BLCC package drawing	2
		SAFETY ADVICES	IEC 60825-1 removed	5

iC-Haus expressly reserves the right to change its products and/or specifications. A Datasheet Update Notification (DUN) gives details as to any amendments and additions made to the relevant current specifications on our internet website www.ichaus.com/DUN and is automatically generated and shall be sent to registered users by email.

Copying – even as an excerpt – is only permitted with iC-Haus' approval in writing and precise reference to source.

The data specified is intended solely for the purpose of product description and shall represent the usual quality of the product. In case the specifications contain obvious mistakes e.g. in writing or calculation, iC-Haus reserves the right to correct the specification and no liability arises insofar that the specification was from a third party view obviously not reliable. There shall be no claims based on defects as to quality in cases of insignificant deviations from the specifications or in case of only minor impairment of usability.

No representations or warranties, either expressed or implied, of merchantability, fitness for a particular purpose or of any other nature are made hereunder with respect to information/specification or the products to which information refers and no guarantee with respect to compliance to the intended use is given. In particular, this also applies to the stated possible applications or areas of applications of the product.

iC-Haus products are not designed for and must not be used in connection with any applications where the failure of such products would reasonably be expected to result in significant personal injury or death (*Safety-Critical Applications*) without iC-Haus' specific written consent. Safety-Critical Applications include, without limitation, life support devices and systems. iC-Haus products are not designed nor intended for use in military or aerospace applications or environments or in automotive applications unless specifically designated for such use by iC-Haus.

iC-Haus conveys no patent, copyright, mask work right or other trade mark right to this product. iC-Haus assumes no liability for any patent and/or other trade mark rights of a third party resulting from processing or handling of the product and/or any other use of the product.

Software and its documentation is provided by iC-Haus GmbH or contributors "AS IS" and is subject to the ZVEI General Conditions for the Supply of Products and Services with iC-Haus amendments and the ZVEI Software clause with iC-Haus amendments (www.ichaus.com/EULA).

* Release Date format: YYYY-MM-DD

iC-TL46 BLCC SD1C

Blue LED - SMD, 3.4 mm spot size



Rev B1, Page 7/7

ORDERING INFORMATION

Type	Package	Order Designation
iC-TL46	2-Pin BLCC, 8 mm x 6 mm, height 5.3 mm RoHS compliant	iC-TL46 BLCC SD1C

Please send your purchase orders to our order handling team:

Fax: +49 (0) 61 35 - 92 92 - 692
E-Mail: dispo@ichaus.com

For technical support, information about prices and terms of delivery please contact:

iC-Haus GmbH
Am Kuemmerling 18
D-55294 Bodenheim
GERMANY

Tel.: +49 (0) 61 35 - 92 92 - 0
Fax: +49 (0) 61 35 - 92 92 - 192
Web: <http://www.ichaus.com>
E-Mail: sales@ichaus.com

Appointed local distributors: http://www.ichaus.com/sales_partners